

IHS/IHSa SERIES

(P.N. 700660189, Revision D1, July 2013)

Software version 1.0/A1.0

Easy Reference:

Model name of the scale:	
Serial number of the unit:	
Software revision number (Displayed when power is first turned on):	
Date of Purchase:	
Name of the supplier and place:	

1.0 CONTENTS

1.0 CONTENTS.....	1
2.0 INTRODUCTION.....	2
2.1 INTRODUCTION.....	2
2.2 TECHNICAL SPECIFICATIONS.....	3
2.3 SAFETY NOTICE	4
2.4 KEY DESCRIPTION.....	5
2.5 DISPLAY.....	5
3.0 OPERATION	7
3.1 SAFETY INSTRUCTIONS.....	7
3.2 BATTERY OPERATION	8
3.3 CHARGING BATTERY.....	9
3.4 BASIC OPERATIONS	9
4.0 CALIBRATION	11
5.0 PARAMETER.....	12

2.0 INTRODUCTION

2.1 INTRODUCTION

The **IHS/IHSa** Series is a range of heavy-duty crane scales used to weigh very large masses.

The main features include:

- Easy Operation & Rugged construction
- 30mm super big & bright red LED display with view angle.
- 360 degree rotary safety hook design, easy to use
- Hold feature
- Overload safety up to 200%
- One charge can last 150 hours
- Auto power off after 30 minutes of non use
- 7.2Vdc 2 amp battery charger
- Aluminum die-casting housing
- Large remote control handset

2.2 TECHNICAL SPECIFICATIONS

Model No	Capacity	Division	Model No.	Capacity	Division
IHS 1	1000kg	0.2kg/0.5kg	IHS 2a	2000lb/1000kg	0.5lb/0.2kg
IHS 3	3000kg	0.5kg/1kg	IHS 6a	6000lb/3000kg	1lb/0.5kg
IHS 5	5000kg	1kg/2kg	IHS 10a	10000lb/5000kg	2lb/1kg
IHS 10	10000kg	2kg/5kg	IHS 20a	20000lb/10000kg	5lb/2kg

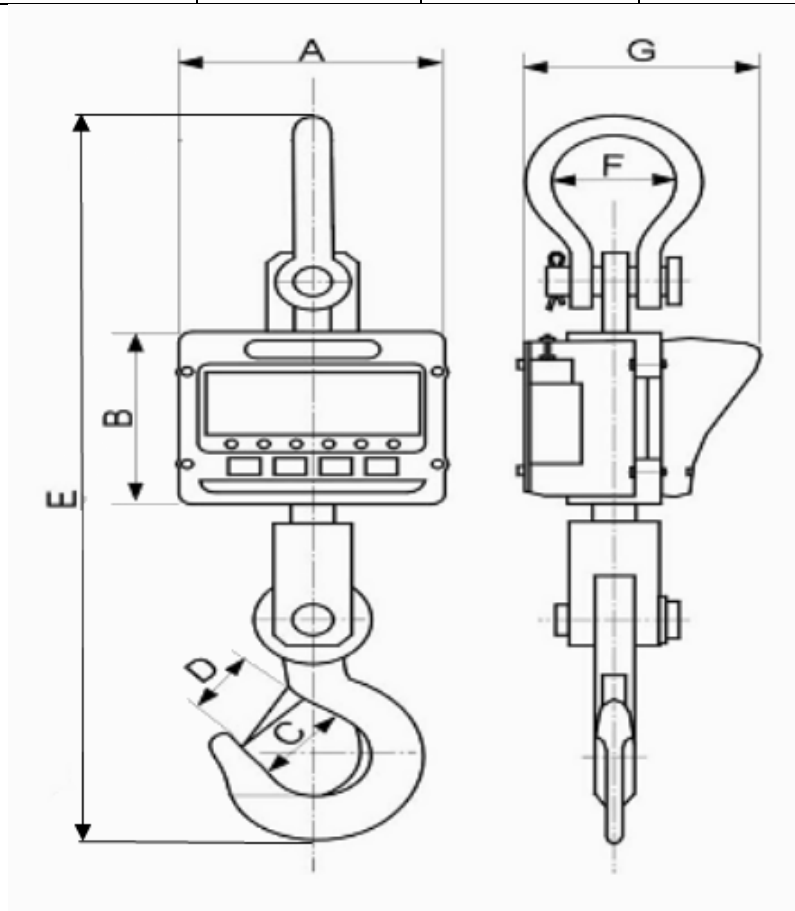

Model	A	B	C	D	E	F	G	Weight
IHS 1/2a	260	203	47	30	628	76	214	12kg
IHS 3/6a	260	203	47	30	628	76	214	14kg
IHS 5/10a	260	203	60	40	723	80	214	19kg
IHS 10/20a	260	203	70	50	837	90	214	31kg

2.3 SAFETY NOTICE

The limit stated below is the Ultimate Overload Limits of the scales.

Adam Equipment Co. Ltd. Its directors, owners and affiliated companies and organisations cannot be held liable for any resulting damage or injury sustained as a result of the machines being used in excess of their stated capacities or ultimate overload limits.

Model NO.	IHS 1/IHS 2a	IHS 3/IHS 6a	IHS 5/IHS 10a	IHS 10/IHS 20a
Max capacity	1000kg/2000lb	3000kg/6000lb	5000kg/10000lb	10000kg/20000lb
Overload capacity	1500kg/3000lb	4500kg/9000lb	7500kg/15000lb	15000kg/30000lb

NOTICE:

Do not use the scales if any parts are bent or loose or show signs of damage or wear. Refer to the user manual.

2.4 KEY DESCRIPTION IHS VERSION

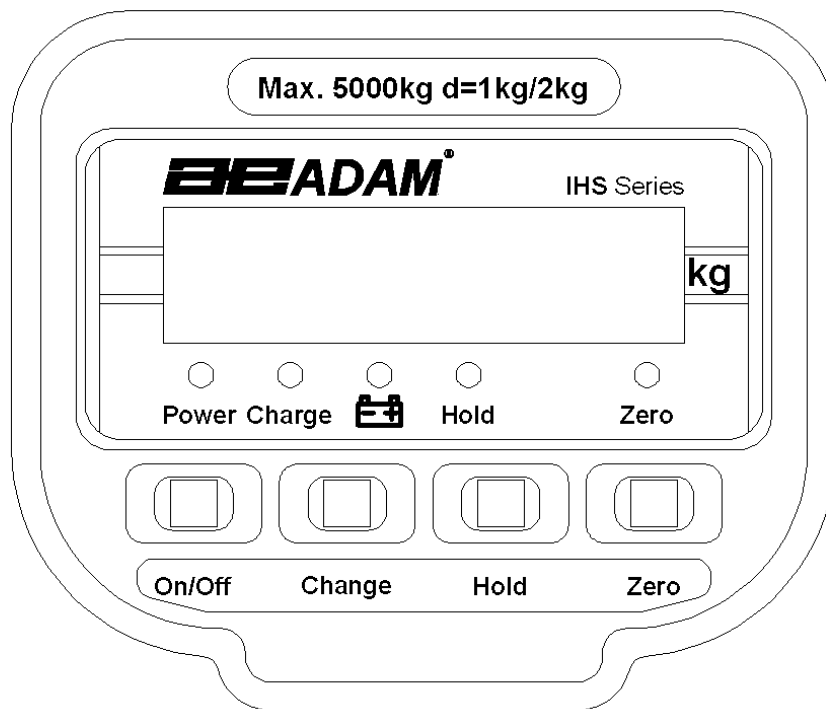

[On/Off]	Power switch- use this key to turn on and turn off the scale.
[Change]	Division change key- use this key to change division. When in setting mode, use this key to change parameter.
[Hold]	Hold function; use this key to lock the display. There is a LED indication light on the bottom of the display. Press the [Hold] key again, to cancel HOLD function.
[Zero]	Re-zero key- use this key to return to zero reading.

2.5 DISPLAY

Power	Power on mode
Charge	Charging mode
	Low battery
Hold	Hold mode
Zero	Zero indicator

2.4 KEY DESCRIPTION IHSa VERSION

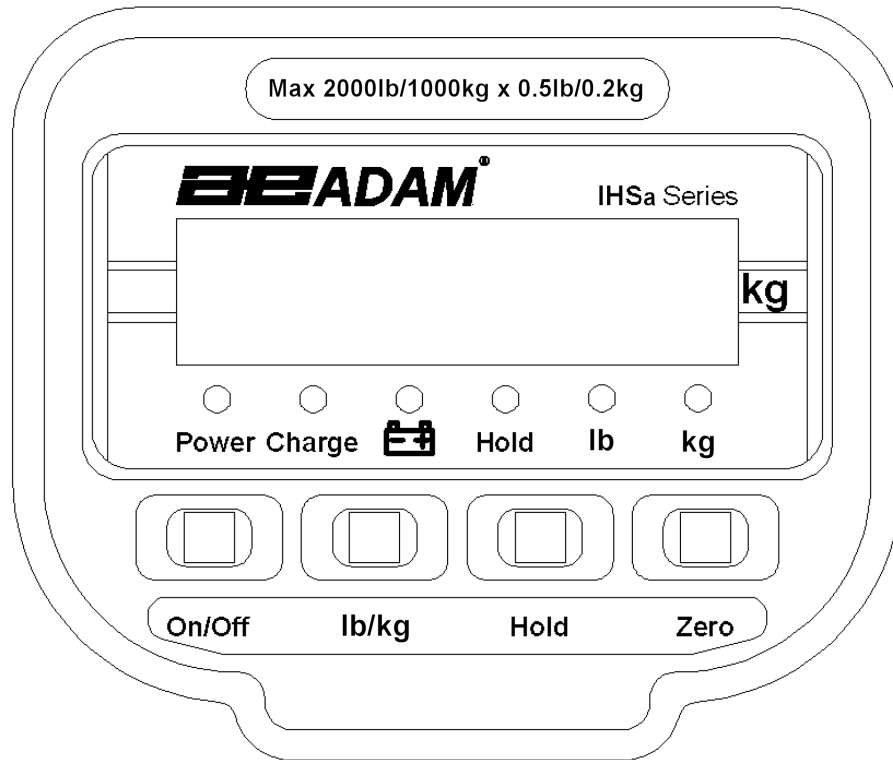

[On/Off]	Power switch- use this key to turn on and turn off the scale.
[lb/kg]	Unit change key-use this key to select the weighing unit of lb or kg. When in setting mode, use this key to change parameter.
[Hold]	Hold function, use this key to lock the display. There is a LED indication light on the bottom of the display. Press the [Hold] key again, to cancel HOLD function.
[Zero]	Re-zero key- use this key to return to zero reading.

2.5 DISPLAY

Zero	Zero indicator
Charge	Charging mode
	Low battery
Hold	Hold mode
lb	LB weighing mode
kg	KG weighing mode

3.0 OPERATION

3.1 SAFETY INSTRUCTIONS

Read this manual carefully before you operate the IHS Crane Scale.

- Unpack the Crane Scale carefully from the packing.
- Attach it to your hoist or equivalent existing equipment securely at the ground level, in the upright position. Make sure that the equipment to which the scale is attached is in proper condition. The operator should be trained for its safe operation.
- Carry out regular visual inspection for any damage or wear and tear on parts. Particularly the split pins at the hook and eyebolts and the inner wall of the hook and all joints should be checked regularly. If any damage or wear has taken place, replace the parts.
- Do all inspection and maintenance work when the scale is not in use.
- Do not expose the scale to extreme temperatures. The operating temperature range is 0° C to 40° C.
- Secure the sample to be weighed in the hook of the scale. Ensure that the sprung Safety Lever returns to its resting position which prevents the sample from slipping out of the hook.
- Do not exceed the maximum capacity of the Scale .
- Clean and protect your scale after use.

3.2 BATTERY OPERATION

- The battery will operate continuously for 150 hours before requiring recharging. The scale will alert you when the battery is within 10 hours of requiring recharging by the indicator lamp above the low battery symbol to indicate that the battery is low voltage.
- When the battery requires charging, the scale will turn off to prevent battery damage. If the button is depressed at this point, the indicator lamp will reappear and then the scale will again deactivate automatically.
- Charging time for a completely discharged battery is approximately 16 hours. A full battery pack is recommended to keep the scale continuously operational.
- The scale will automatically power down after 30 minutes of non use to further protect the battery.

Note: More frequent charging of the battery prolongs its life.

3.3 CHARGING BATTERY

- Plug the power supply into the mains power, then into the back of the IHS scale.
- The red indicator lamp will illuminate to indicate that the battery charger is functioning properly.
- The green indicator lamp will illuminate to indicate that the battery fully charged.

3.4 BASIC OPERATIONS

Power on and off- Press [**On/Off**] key to turn on the scale . Then the display on the scale will show **188888**. Press again to turn off the scale.

Zero the scale-Depress the [**Zero**] to re-zero the reading.

Change division- you can use the [**Change/lb/kg**] key to change division.

Lb/kg- you use this to select either lb or kg weighing units

Hold -when required, such as when the reading is not stable or you cannot pause to record a reading, you can use the [**Hold**] key to lock the reading, so that you can read it easily later, after you finish reading, press [**Hold**] again to return to normal weighing mode.

Note: The [**Hold**] key has no affect if the Hold parameter has been disabled. See section 5.1

Overload Warning:- please do not add any item that exceeds the maximum capacity of the scale. When the buzzer is sounded and the display shows "----", remove the item to avoid damage to the load cell and scale.

3.5 REMOTE CONTROLLER

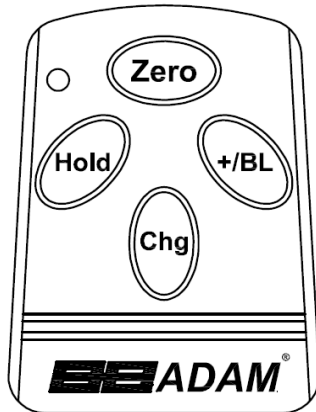

- A: Determine increments in which the weight display
- B: Hold the settled values
- C: Zero the scale
- D: Backlight (only used on scales with LCD display)

4.0 CALIBRATION

- Hold **[Zero]** when the scale is powered on.
- The display on the scale will show “SPAN”. Make sure the hook is empty or has the slings or chains to be used in place. See Below.
- Depress the **[Zero]** button, the display on the scale will show “Set” then “0” and then “0000.0” after few seconds. zero calibration is now complete.
- Enter the weight to calibrate with by using **[Hold]** key to increment a digit then the **[Change/lb/kg]** key to move it across the screen left.
- For example, the display on the IHS will display “3000.0” for a 3 ton calibration mass.
- Add the calibrated mass on the hook, it the best that the mass is close to the capacity where possible.
- When the scale is stable, press the **[Zero]**. The display shows ‘HOLD’.
- After a few seconds, the calibration is complete.

** To calibrate in pounds (lb) make sure that the scale is lb mode before commencing, to calibrate in kilograms (kg) make sure the scale is in kg mode before commencing.

When using slings, chains or other material to support the calibration mass, these items should be hung from the scale before setting the zero point so that when the calibration mass is added, only the weight of the calibration mass is measured by the scale.

If an error is detected when calibrating an error message will be shown.

Err 3 is when wrong data is entered for the mass, i.e. too small or wrong division.

Err-5 means the calibration has failed.

5.0 PARAMETER

5.1 ENTER SETTING MODE

Turn off the power of the scale and then turn the power on again.

Press the [**Change/lb/kg**] key during self-checking, display shows "**Bee0**", indicating the scale has entered the setting mode, press the [**Hold**] or [**Change/lb/kg**] key to shift the parameter items. Use [**Zero**] key confirm and escape from setting the current item.

5.2 PARAMETER SETTING TABLE

FUNCTION	DESCRIPTION	DEFAULT
bEE	Sets buzzer 0: Disable 1: Enable	0
Hod	Sets hold function 0: Disable 1: Enable	0
Stb	Sets zero function STb0: zeroing allowed when unstable STb1: zeroing not allowed when unstable	0
Aut	Sets auto backlight: (Only applies when the scale has an LCD display) AUTO : manual AUT1 : auto	0
CHt	Sets units 0: lb 1: kg	1
YES	Sets save: 0: not saved 1: save	0



Manufacturer's Declaration of Conformity

This product has been manufactured in accordance with the harmonised European standards, following the provisions of the below stated directives:

Restriction of the use of certain hazardous substances
in electrical and electronic equipment 2011/65/EC (RoSH)

Electro Magnetic Compatibility Directive 2004/108/EC

Low Voltage Directive 2006/95/EC

Adam Equipment Co.
Maidstone Road, Kingston
Milton Keynes, MK10 0BD
United Kingdom

FCC COMPLIANCE

This equipment has been tested and found to comply with the limits for a Class A digital device, pursuant to Part 15 of the FCC Rules. These limits are designed to provide reasonable protection against harmful interference when the equipment is operated in a commercial environment. The equipment generates, uses, and can radiate radio frequency energy and, if not installed and used in accordance with the instruction manual, may cause harmful interference to radio communications. Operation of this equipment in a residential area is likely to cause harmful interference in which case the user will be required to correct the interference at his own expense.

Shielded interconnect cables must be employed with this equipment to insure compliance with the pertinent RF emission limits governing this device.

Changes or modifications not expressly approved by Adam Equipment could void the user's authority to operate the equipment.

WEEE COMPLIANCE

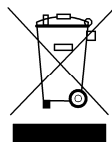

Sealed Lead Acid
Battery
Must be recycled
Properly

Any Electrical or Electronic Equipment (EEE) component or assembly of parts intended to be incorporated into EEE devices as defined by European Directive 2002/95/EEC must be recycled or disposed using techniques that do not introduce hazardous substances harmful to our health or the environment as listed in Directive 2002/95/EC or amending legislation. Battery disposal in Landfill Sites is more regulated since July 2002 by regulation 9 of the Landfill (England and Wales) Regulations 2002 and Hazardous Waste Regulations 2005. Battery recycling has become topical and the Waste Electrical and Electronic Equipment (WEEE) Regulations are set to impose targets for recycling.

ADAM EQUIPMENT is an ISO 9001:2008 certified global company with more than 35 years experience in the production and sale of electronic weighing equipment.

Adam products are predominantly designed for the Laboratory, Educational, Health and Fitness, retail and Industrial Segments. The product range can be described as follows:

- Analytical and Precision Balances
- Compact and Portable Balances
- High Capacity Balances
- Moisture analysers / balances
- Mechanical Scales
- Counting Scales
- Digital Weighing/Check-weighing Scales
- High performance Platform Scales
- Crane scales
- Health and Fitness Scales
- Retail Scales for Price computing

For a complete listing of all Adam products visit our website at
www.adamequipment.com